

LS10

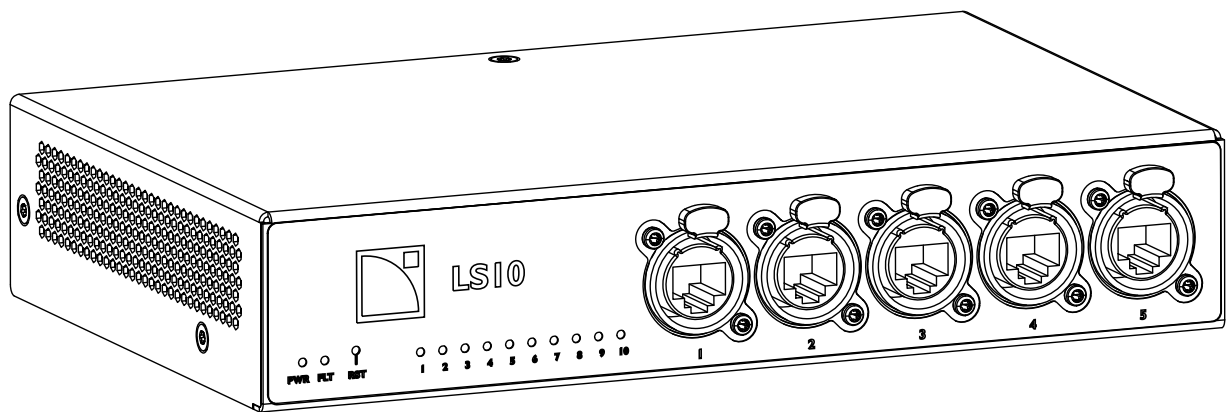

owner's manual (EN)



Document reference: LS10 owner's manual (EN) version 5.0

Distribution date: November 12, 2024

© 2024 L-Acoustics. All rights reserved.

No part of this publication may be reproduced or transmitted in any form or by any means without the express written consent of the publisher.











Contents

Safety.....	5
Important safety instructions.....	5
Introduction.....	7
LS10 Avnu™-certified AVB switch.....	7
How to use this manual.....	7
Revision history.....	8
System components.....	9
System component illustrations.....	9
Technical description.....	11
Main features.....	11
Components.....	11
Front and rear panels.....	12
Ethernet ports.....	12
Power supply.....	12
Inspection and preventive maintenance.....	13
How to do preventive maintenance.....	13
CHK - External structure.....	13
CHK - External cleanness.....	13
CHK - Normal start-up sequence.....	14
CHK - Network functionalities and firmware.....	14
Installation.....	15
Mounting.....	15
Ventilation.....	17
General Purpose Output (GPO).....	17
24 V DC Input and Output.....	18
Network cabling.....	20
Connection panels.....	20
Cabling examples.....	22
Connecting to AC mains.....	24
Electrical specifications.....	24
Power cord.....	24
Plugging to AC mains.....	25
Power consumption.....	25
Powering on/off.....	25

Operation.....	26
LS10 LED colors.....	26
Reset button.....	26
LS10 Manager.....	27
LS10 embedded Web interface.....	27
Top bar.....	27
Overview.....	28
GPO.....	30
Settings.....	31
Additional actions.....	34
Specifications.....	35
Appendix.....	38
Appendix A: Glossary.....	38
Appendix B: Approvals.....	39
Appendix C: QoS priority queues.....	41

Safety

Important safety instructions

- 
Inspect the product before operation.
 If any sign of defect or damage is detected, immediately withdraw the product from use for maintenance.
 - 
Perform preventive maintenance at least once a year.
 Refer to the preventive maintenance section for a list of actions and their periodicity.
 Insufficient upkeep of the product can void the warranty.
 - 
Verify the electrical conformity and compatibility of the mains supply.
 Only connect the product to an AC power source rated 100-240 V, 50-60 Hz or to a DC power source with double insulation or reinforced insulation rated 24 V and 10 W maximum.
 The product draws 10 W (typical).
 The product draws 20 W (typical) when it powers another LS10.
WARNING: The product is of Class I construction and shall be connected to a mains socket outlet with a Protective Earth connection.
 - 
When the product is used in a three-phase circuit, verify the electrical conformity and compatibility of the three-phase circuit.
 Verify that the three phases work, and balance the loads between the three phases.
 Verify that the neutral and earth work.
 Never try to emulate a 230 V circuit connecting an apparatus to two live wires of a 120 V three-phase circuit.
 Never try to emulate a 200 V circuit connecting an apparatus to two live wires of a 100 V three-phase circuit.
 - 
Electrical generator
 You must power on the generator before powering on the product.
 Verify that the product is turned off before powering on the generator.
 - 
Never incorporate equipment or accessories not approved by L-Acoustics.
Read all the related PRODUCT INFORMATION documents shipped with the products before exploiting the system.
 - 
Intended use
 This system is intended for use by trained personnel for professional applications.
 - 
As part of a continuous evolution of techniques and standards, L-Acoustics reserves the right to change the specifications of its products and the content of its documents without prior notice.
 Check www.l-acoustics.com on a regular basis to download the latest document and software updates.
 - 
Do not expose the product to extreme conditions.
 Do not expose the product to moisture (rain, mist, sea spray, steam, humidity, condensation...) or excessive heat (direct sun, radiator...) for a long period of time.
 For more information, refer to the **Products weather protection** document, available on the website.
 - 
Do not use the product outside its operating temperature range.
 The product operates at a room temperature between -5 °C / 23 °F and 50 °C / 122 °F.
 Do not expose the product to direct sun.
 - 
Use the product in a conformed electro-magnetic environment.
 The product can be used in the following environment: residential (class B).
- Avoid radio interference.**
 This product has been tested and complies with the regulations of the EMC directive (Electro Magnetic Compatibility). These regulations are designed to provide reasonable protection against harmful interference from electrical equipment, but it cannot be guaranteed that interference will never occur.



Product disconnection

To completely disconnect this product from the mains, disconnect the power supply cord plug from the mains socket outlet.



Power supply cord and socket accessibility

The main plug of the power supply cord shall remain easily accessible.
The mains socket outlet shall be easily accessible.



Read the maintenance section of this document before servicing the product.



Contact L-Acoustics for advanced maintenance.

Any unauthorized maintenance operation will void the product warranty.



Shipping

Use the original packaging for shipping the product.



This marking indicates that this product should not be disposed of with other household waste throughout the EU. To prevent possible harm to the environment or human health from uncontrolled waste disposal, recycle it responsibly to promote the sustainable reuse of material resources. To return your used device, please use the return and collection systems or contact the retailer where the product was purchased. They can take this product for environmentally safe recycling.



Introduction

LS10 Avnu™-certified AVB switch



LS10 is an Avnu™-certified AVB switch that integrates seamlessly within the L-Acoustics ecosystem to further simplify connectivity, uniting audio and control distribution. LS10 runs out-of-the-box AVB, providing a reliable network solution that does not require IT expertise.

On its own or as an integral part of the LA-RAK II AVB and LA-RAK III, LS10 distributes audio and control via front and rear etherCON™ connectors and SFP cages, enabling long-distance optical links. Two units mounted side-by-side on the dedicated 1U rack shelf allow to create a seamless redundant network effortlessly. Upgrading LA-RAK II to LA-RAK II AVB is possible.

The rugged LS10 incorporates features designed to overcome the challenges of touring events but also installation applications. The quick, 5-second, startup time allows for rapid recovery in case of power loss. A configurable GPO port enables status monitoring and the auxiliary DC input offers ultimate reliability.

With LS10, lightning-quick setup of a stable distribution of your AVB signal is ensured without the need for extensive IT knowledge or experience.

How to use this manual

The LS10 owner's manual is intended for all actors involved in the system design, implementation, preventive and corrective maintenance of the LS10 product. It must be used as follows:

1. Read the technical description for an overview of all product elements, their features, and their compatibilities.
 - [Technical description](#) (p.11)
2. Before installing the product, perform mandatory inspections and functional checks.
 - [Inspection and preventive maintenance](#) (p.13)
3. To deploy the product, follow the step-by-step installation instructions and refer to the cabling schemes.
 - [Installation](#) (p.15)
 - [Network cabling](#) (p.20)
4. To configure the settings and parameters of the product, follow the step-by-step operation instructions.
 - [Operation](#) (p.26)

As part of a continuous evolution of techniques and standards, L-Acoustics reserves the right to change the specifications of its products and the content of its documents without prior notice.

Check www.l-acoustics.com on a regular basis to download the latest document and software updates.

Contact information





For information on advanced corrective maintenance:

- contact your Certified Provider or your L-Acoustics representative

- for Certified Providers, contact the L-Acoustics customer service: customer.service@l-acoustics.com (EMEA/APAC), laus.service@l-acoustics.com (Americas).

Symbols

The following symbols are used in this document:

-  This symbol indicates a potential risk of harm to an individual or damage to the product.
It can also notify the user about instructions that must be strictly followed to ensure safe installation or operation of the product.
-  This symbol indicates a potential risk of electrical injury.
It can also notify the user about instructions that must be strictly followed to ensure safe installation or operation of the product.
-  This symbol notifies the user about instructions that must be strictly followed to ensure proper installation or operation of the product.
-  This symbol notifies the user about complementary information or optional instructions.
-  Do not open unless authorized.
This symbol indicates the presence of electrical shock hazards.
It also indicates that no maintenance performed by the end user requires access to internal components.

Revision history

version number	publication date	modification
1.0	Jun. 2019	Initial version.
2.0	May 2020	Updated protection ratings information, altitude specification, and EMC standard.
2.1	Jul. 2020	Added Declaration of Conformity.
2.2	Jul. 2021	<ul style="list-style-type: none"> • Added information about using LS10 as a network switch for a local area network. • Moved information about LS10 Manager and USB Terminal (former Switch Configuration Tool) to LA Network Manager Help.
3.0	Dec. 2021	<ul style="list-style-type: none"> • Updated section about SFP. • Added new cables (DOE2, DOE45, and DOE100). • Added international cable.
4.0	Feb. 2024	Added LS10 embedded Web interface (p.27) section.
4.1	May 2024	Added Ports settings (p.33) section in LS10 embedded Web interface (p.27).
5.0	Nov. 2024	<ul style="list-style-type: none"> • Updated LS10 embedded Web interface (p.27) section. • Added information about Appendix C: QoS priority queues (p.41).

System components

Networking

LS10 Avnu™-certified AVB switch

Racks

LA-RAK II AVB Touring rack containing three LA12X, LA-POWER II for power distribution, LA-PANEL II for audio and network distribution, and two LS10 for AVB distribution

LA-RAK III Touring rack containing three LA7.16, one LA-POWER II for power distribution, one LA-PANEL III for audio signal distribution, and two LS10 for AVB distribution

Cables

DOE cables Dual AVB Network cable CAT6A, etherCON (black = primary network, red = secondary network)

Come in different sizes: DOE2 (2 m / 6.6 ft), DOE45 (45 m / 147.6 ft), and DOE100 (100 m / 328.1 ft)

Connectors

6-point terminal block 6-point terminal block connector (Phoenix MSTB 2,5/ 6-ST - 1754520)

Rigging elements

LS10-RAKSHELF 1U Rack shelf for two LS10

Software applications

LA Network Manager Software for remote control and monitoring of amplified controllers

LS10 embedded Web interface User interface

Accessed by typing the device IP address into a Web browser.

L-Acoustics Device Scanner Discovery and IP configuration utility for L-Acoustics devices (except L-ISA processors) on an Ethernet network



Refer to the LA Network Manager help.

Refer to the L-Acoustics Device Scanner user guide.

System component illustrations

Cables

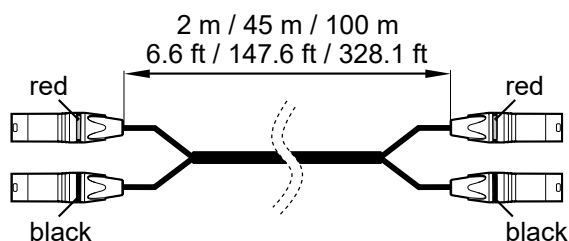

DOE cables

Connectors

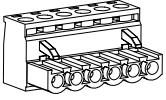

6-point terminal block

Rigging accessories

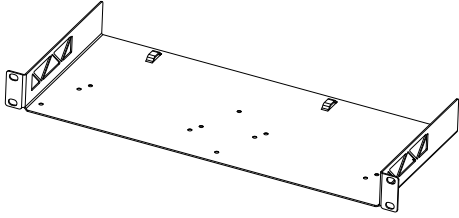

LS10-RAKSHELF

Software applications



LA Network Manager

WebUI

LS10 embedded
Web interface



L-Acoustics
Device Scanner

Technical description

Main features

LS10 is a network switch as per IEEE 802.1Q standard, with ten IEEE 802.3 Ethernet ports. It can also operate as a hub.

LS10 can be used in computer rooms or facilities which are managed and maintained by non-communication operators.

To use LS10 as a hub, connect it to a computer using a RJ45 network cable.

Components

LS10 has 10 Ethernet ports:

- 5 Ethernet etherCON I/Os 1 Gb/s (front side)
- 3 Ethernet etherCON I/Os 1 Gb/s (rear side)
- 2 SFP cages supporting 1 Gb/s interfaces

In addition, the switch features:

- 1 mains power input, IEC C13 V-Lock compatible socket
- 1 6-point terminal block that gathers:
 - 1 24 V DC IN / 1 24 V DC OUT pin for power supply backup
 - GPO for status control
- 1 USB port for maintenance and switch configuration

Front and rear panels

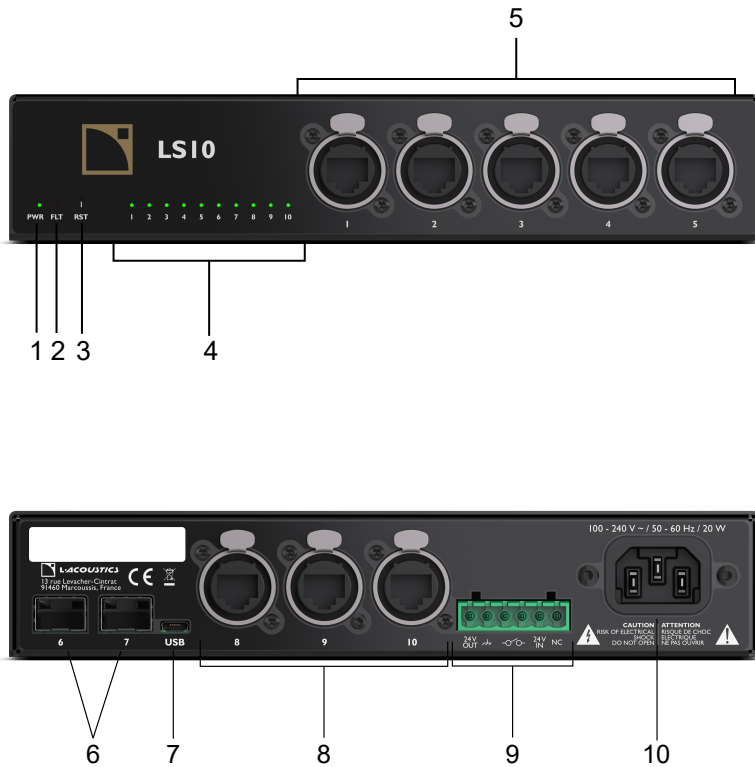

- | | | | |
|----------|--------------------------------|-----------|---|
| 1 | 1 Power indicator | 6 | 2 SFP cages |
| 2 | 1 Fault indicator | 7 | 1 female micro type USB port |
| 3 | 1 Reset button | 8 | 3 Ethernet etherCON I/Os |
| 4 | 10 link status/port indicators | 9 | 1 × 6-point terminal block, step 5 mm |
| 5 | 5 Ethernet etherCON I/Os | 10 | 1 mains power input, IEC C13 V-Lock compatible socket |

Ethernet ports

LS10 features Ethernet ports that can operate at 10 Mbit/s, 100 Mbit/s or 1 Gb/s, in half-duplex or full duplex mode. The operating mode and speed are automatically negotiated with the connected device. The 8 ports equipped with RJ45 also feature auto MDI/MDIX detection to use straight or crossover cables. LS10 supports the management of up to 150 AVB streams regardless of the number of channels of these streams.

Power supply

LS10 relies on a universal Switched Mode Power Supply (SMPS) suitable for mains from 100 V AC to 240 V AC ($\pm 10\%$), 50 Hz to 60 Hz.

Inspection and preventive maintenance

How to do preventive maintenance

Inspect the product periodically as indicated, and after any corrective maintenance operation.

Structure and cleanness

Before and after each deployment (touring applications), or at least once a month (fixed installations):

- [CHK - External structure](#) (p.13)
- [CHK - External cleanness](#) (p.13)

Functionalities

At least once a year:

- [CHK - Normal start-up sequence](#) (p.14)
- [CHK - Network functionalities and firmware](#) (p.14)

CHK - External structure

The  icon indicates a visual inspection.

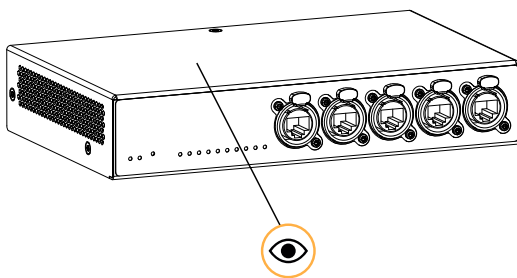

chassis is not damaged

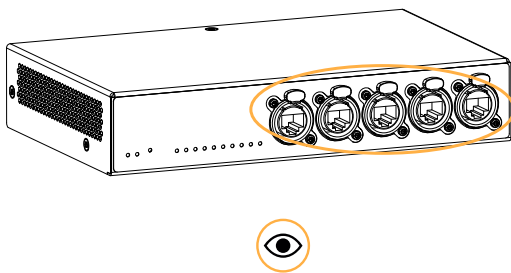

front and rear connectors are not damaged

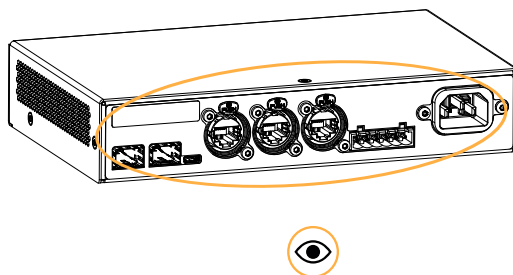

CHK - External cleanness

Use a dry cloth to remove any dust from the side grills.

CHK - Normal start-up sequence

Procedure

1. Plug the switch to mains.
2. Check that all the LEDs light up during the start-up sequence.

CHK - Network functionalities and firmware

Equipment

- computer with LA Network Manager version 3.1.0 minimum
- appropriate network cable (CAT5e, DOE, etc.)



It is recommended to use the latest version of LA Network Manager and the firmware.

Procedure

1. Plug LS10 to mains.
2. Connect LS10 to an Ethernet port of a computer running LA Network Manager.
Use the network cable.
3. Open the LS10 Manager application.
 - a) Open LA Network Manager.
 - b) Click > **Utilities** > **LS10 Manager**.
Refer to the **LA Network Manager help** for more information.
 - c) Scan the network.
4. Check that the switch is detected by the application.
Refer to [LS10 Manager](#) (p.27) for more information.
5. Perform the firmware update.
6. Check that all L-Acoustics switches in the system run the same version of the firmware.

Installation

Mounting

LS10 is one rack unit high (1U) and a half rack unit wide. LS10-RAKSHELF is a rigging accessory that can contain up to two LS10 side by side. LS10-RAKSHELF is mounted to LA-RAK II AVB and LA-RAK III, and can be mounted to LA-RAK II as well as other 19-inch racks.

Mounting two LS10 on LS10-RAKSHELF

Tools

- torque screwdriver
- T10 Torx bit

Material



×6

S100243

M3×6 Torx

There are three different mounting configurations for LS10 on LS10-RAKSHELF:

- side by side in front position (default)

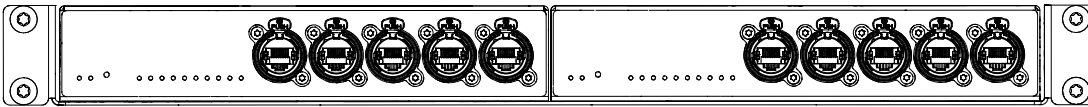

- side by side in rear position

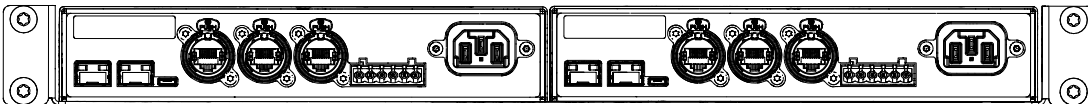

- side by side with one in inverted position

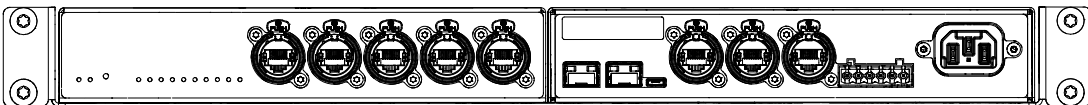

Procedure

1. Turn upside down one or two LS10 and revert the LS10-RAKSHELF on top.

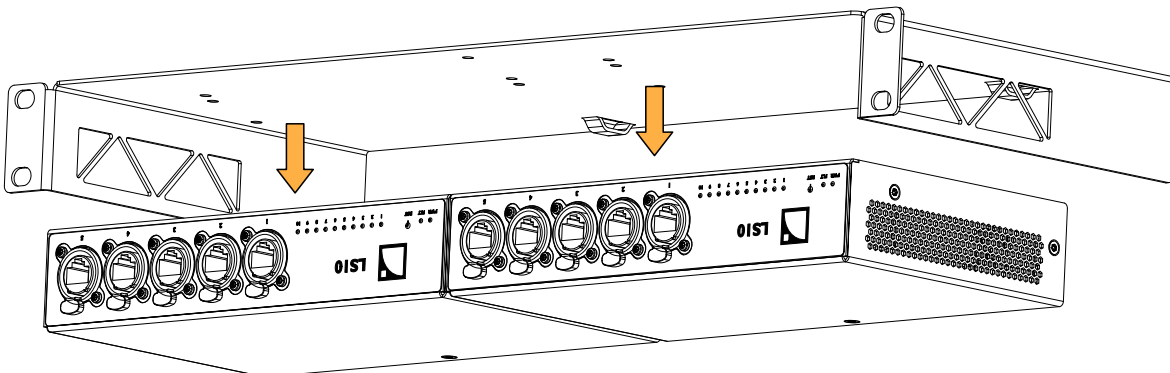

2. Place the six screws in the appropriate holes.

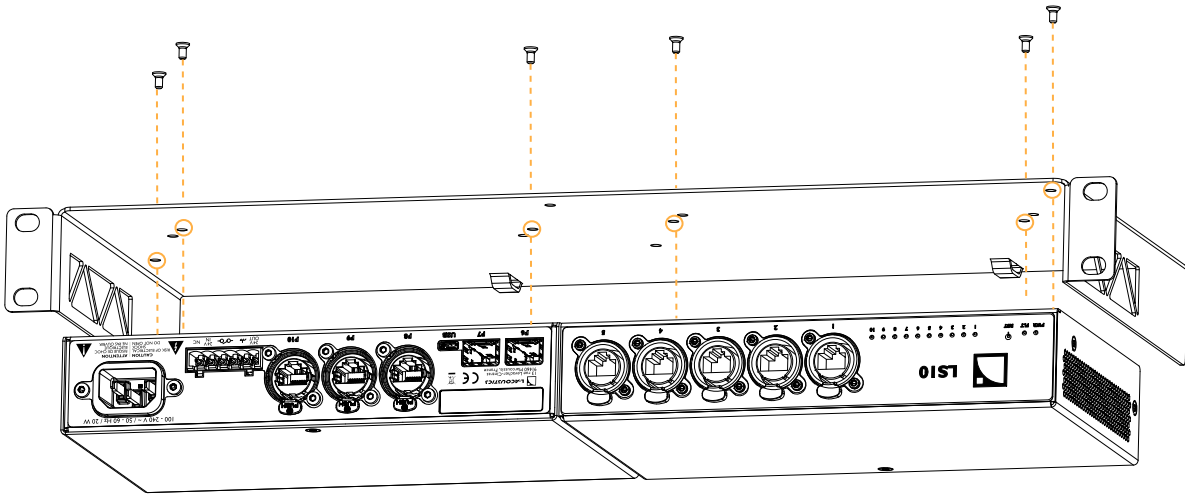

3. Tighten the screws.

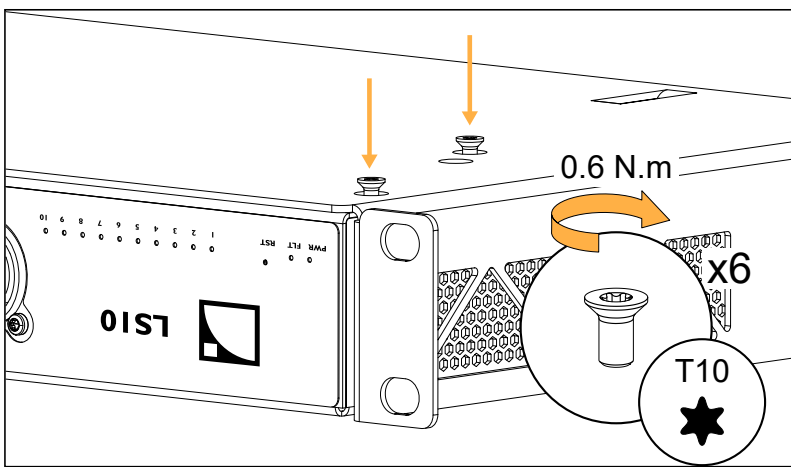

4. Turn back the assembly to nominal position for cabling and mounting.

Ventilation

LS10 is equipped with one grill on each side to ventilate the system.



Do not block the side ventilation grills.

Install the switch with the side panels at a minimum distance of 5 cm (1.9 in)^{*} from any external object or structure.

The same distance of 5 cm must be guaranteed on both sides of the rack.

When rack-mounted, make sure airflow is not reduced.

General Purpose Output (GPO)

LS10 features a 6-point terminal block on the rear panel that includes a configurable GPO to indicate the presence of a fault on the LS10. It can be connected with a 6-point terminal block.

The pitch of the connector is 5 mm.

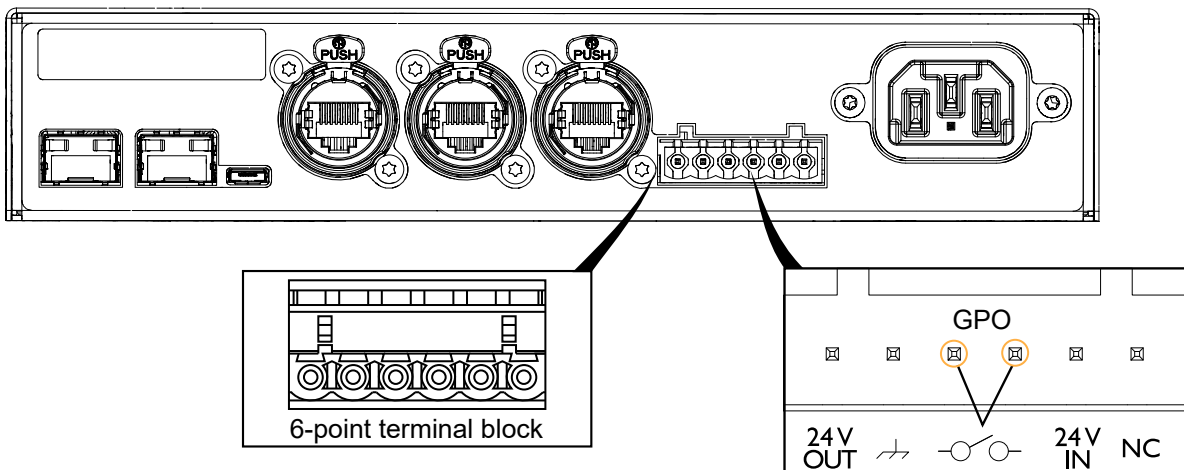

GPO is controlled by a Normally Open (NO) relay that can operate in a circuit with up to 30 V DC, 1 A.

Relay max rating

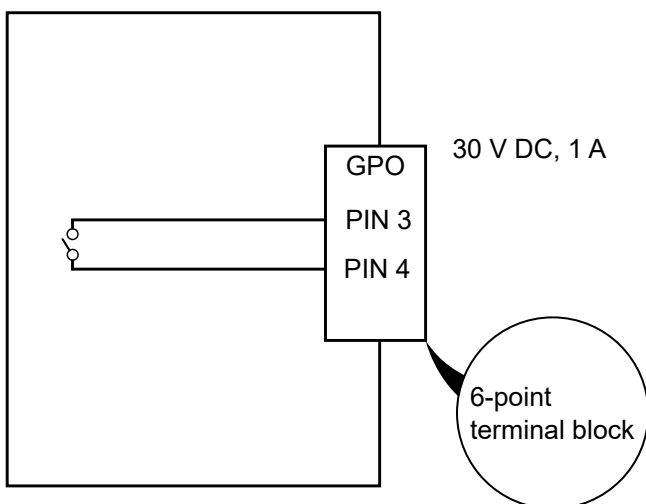

Relay is open when the unit is unpowered.

GPO can be configured using the L-Acoustics LS10 Manager.



For more information, refer to the [LS10 Manager](#) (p.27) section.

^{*} This distance is respected when mounted in LA-RAK II AVB or LA-RAK III.

24 V DC Input and Output

24 V DC Input and Output pins allow to power another LS10 with a redundant powering.

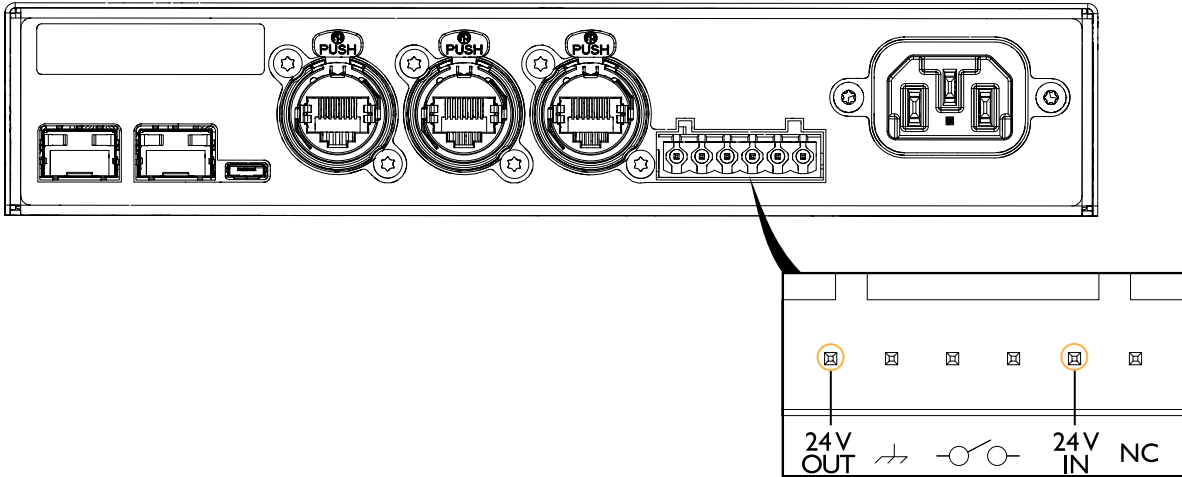

It is also possible to power LS10 with an external power supply.

Backup power cable

In case of component fault inside one LS10, the other LS10 will automatically provide backup power thanks to this cable. To do so, each LS10 must be connected to independent power sources.

This cable can be made with two Phoenix™ connectors (reference MSTB 2,5/ 6-ST - 1754520 for example) and a cable with three conductors such as Alpha Wire™ (reference 1896L SL005). Connectors and cable conductors are connected as follows:

- cable conductor from PIN 1 to PIN 5
- cable conductor from PIN 2 to PIN 2
- cable conductor from PIN 5 to PIN 1

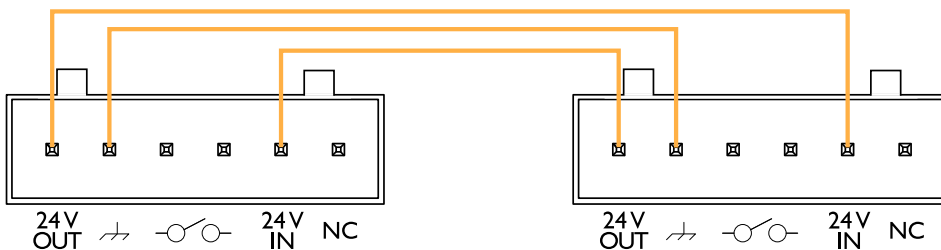

Backup powering

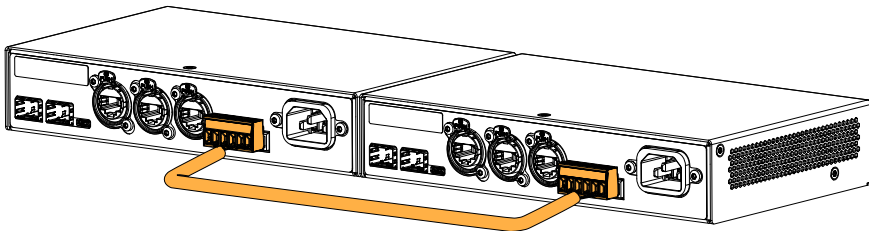

External 24 V DC powering

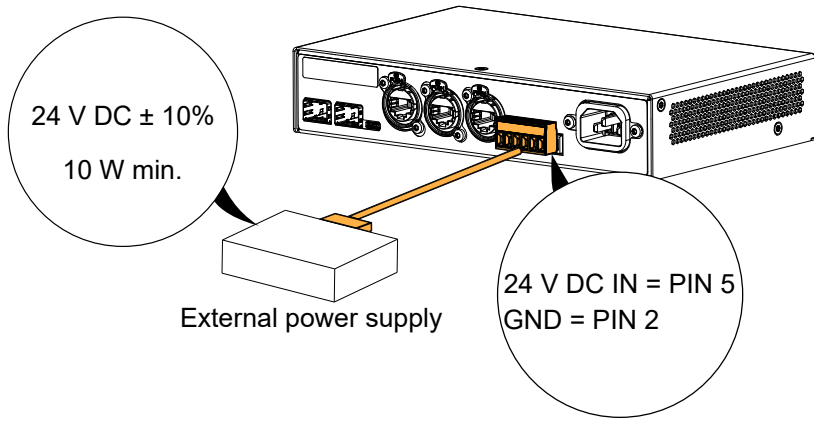

Network cabling

Connection panels

LS10 features connectors on its front and rear panels for network connection.

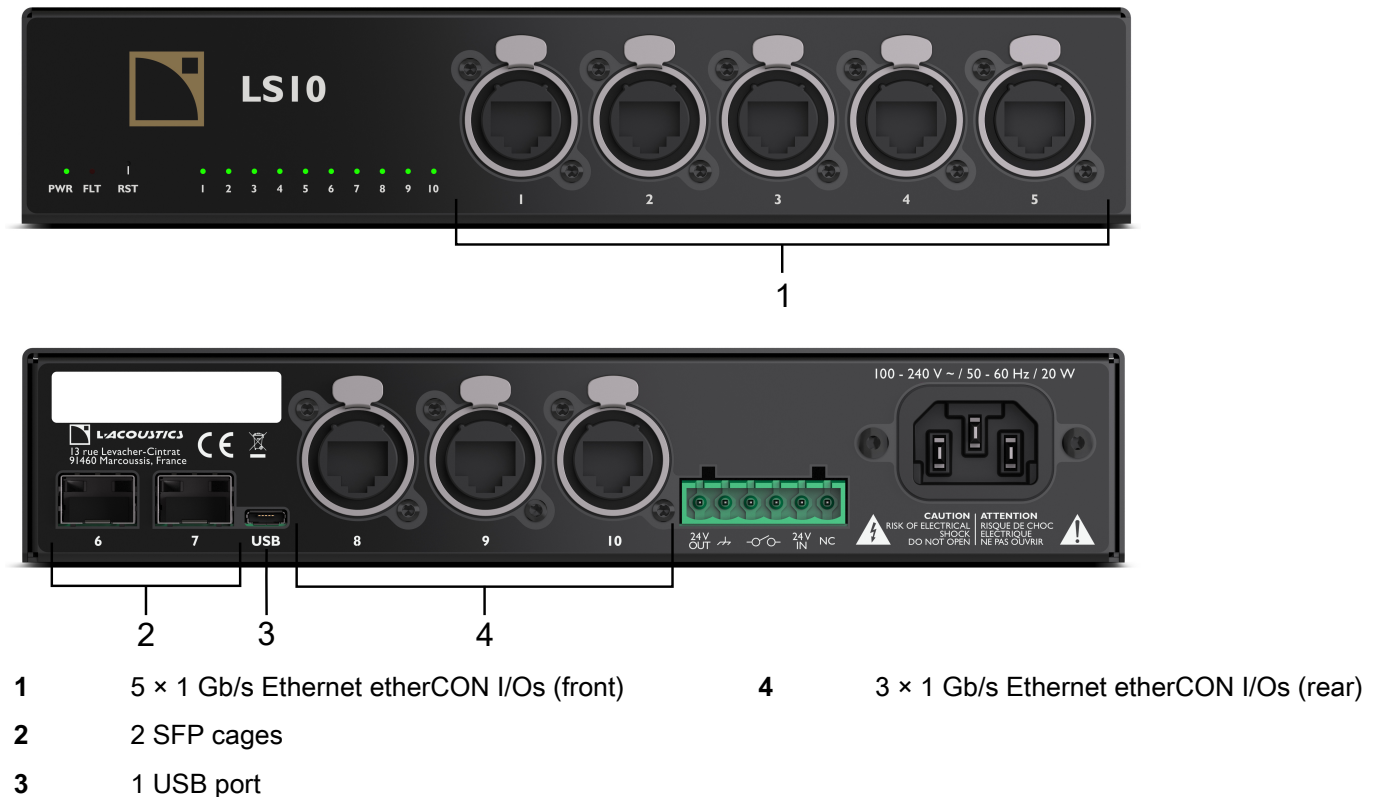

SFP cages

The SFP cages are compatible with RJ45 or optical SFP modules. The SFP ports can operate at up to 1 Gb/s. The SFP optical modules allow to extend the maximum link length:

- 1000BASE-SX SFP modules and multi-mode fiber enable links of up to 550 m (typical)
- 1000BASE-LX SFP modules and single-mode fiber allow for up to 5000 m (typical)

Refer to the module manufacturer for more information.

Any module compliant with the SFP specification should operate normally in LS10. As an indication, the following SFP modules have been successfully tested with LS10:

- for RJ45: Bel SFP-1GBT-06, Auvitran AxP-RJ
- for multi-mode dual fiber: Avago AFBR-5710PZ, FS SFP1G-SX-85, Finisar FTLF8519P3BNL, Cisco GLC-SX-MMD
- for single-mode dual fiber: Auvitran AxP-LX
- for single-mode bidirectional fiber (modules are sold by pair): FS SFP-GE-BX #39143 and #39146, FS SFP-GE-BX #39135 and #39138.

USB

The female micro type USB port is used for maintenance operations and for switch configuration. Refer to [LS10 Manager](#) (p.27) for more information.

Ethernet connectors

The Ethernet etherCON I/Os allow to create a local area network (LAN) using Ethernet or Ethernet AVB devices such as P1, LA4X or LA12X.

A LAN network can be created by connecting the switch to a router, and Ethernet devices to the switch, using industry standard cables fitted with RJ45 connectors.

Multiple network topologies such as star and hybrid are configurable for L-NET or Milan-AVB networks. The computer and the switches are connected to each other using industry standard cables fitted with optical modules or RJ45 connectors.

Refer to the **LA Network Manager Help** for more information on how to create an L-NET or Milan-AVB network in star or hybrid topologies.

Cabling examples

Example of a local area network

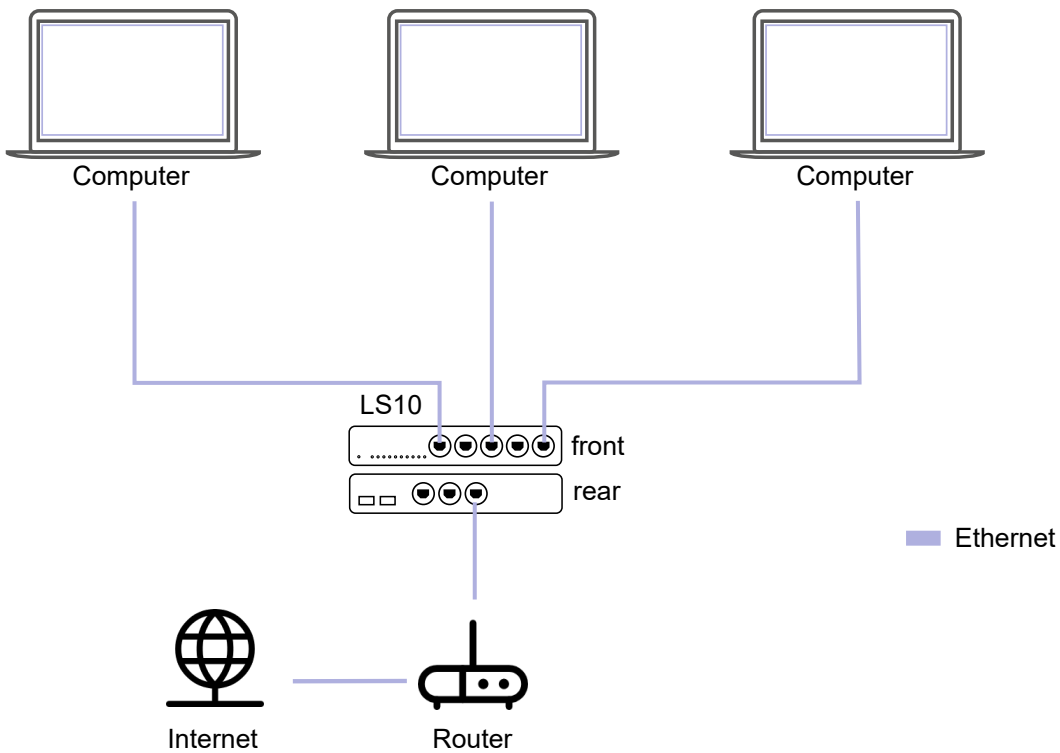

Example of non-redundant network with hybrid topology

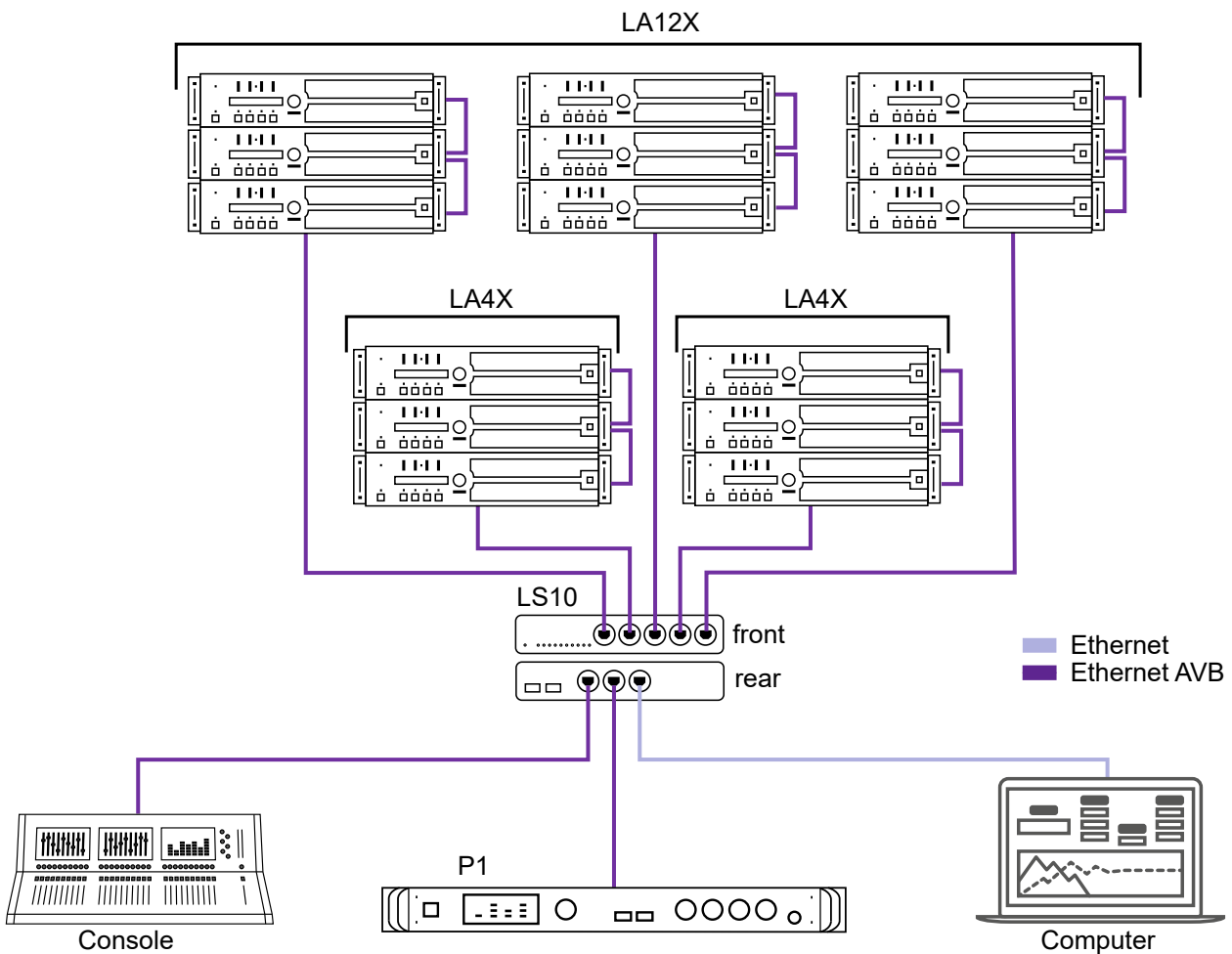

Example of redundancy topology

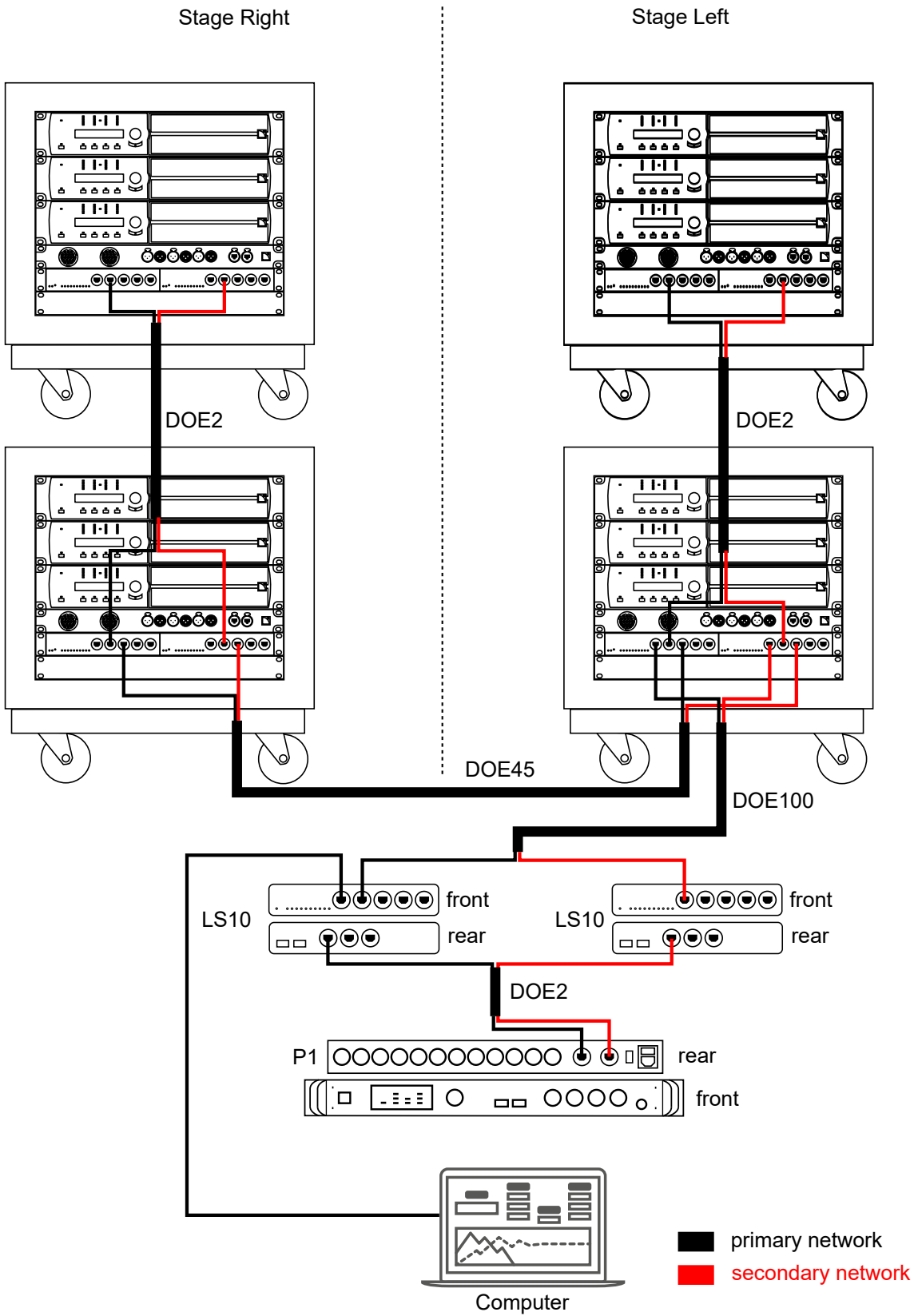

Connecting to AC mains

Electrical specifications

AC mains specifications



Verify the electrical conformity and compatibility of the mains supply.

Only connect the product to an AC power source rated 100-240 V, 50-60 Hz or to a DC power source with double insulation or reinforced insulation rated 24 V and 10 W maximum.

The product draws 10 W (typical).

The product draws 20 W (typical) when it powers another LS10.

WARNING: The product is of Class I construction and shall be connected to a mains socket outlet with a Protective Earth connection.

Three-phase circuit



When the product is used in a three-phase circuit, verify the electrical conformity and compatibility of the three-phase circuit.

Verify that the three phases work, and balance the loads between the three phases.

Verify that the neutral and earth work.

Never try to emulate a 230 V circuit connecting an apparatus to two live wires of a 120 V three-phase circuit.

Never try to emulate a 200 V circuit connecting an apparatus to two live wires of a 100 V three-phase circuit.

Power cord

The removable IEC cord is fitted with a female IEC C13 connector with V-Lock at one end and a country-specific plug at the other end.

type	plug	cable ratings	live	neutral	ground
CE	CEE 7/7, earthed	10 A / 250 V	brown	blue	green/yellow
CN	GB 2099, earthed				
INT	bare ends (local power plug to be fitted)				
JP	JIS C 8303, earthed	7 A / 125 V	black	white	green
US	NEMA 5-15, earthed	10 A / 125 V			



Strictly apply the specific safety regulations of the country of use.

Do not defeat the ground connection of the supplied power cord using an adaptor or any other method.

A suitable plug must be wired to the INT power cord.

Verify that the plug conforms to the specific voltage and current rating given in section [Electrical specifications](#) (p.24).

Plugging to AC mains

Procedure

1. Connect the power cord female IEC C13 connector to the switch male IEC C14 socket.



Check that the cable is properly locked.

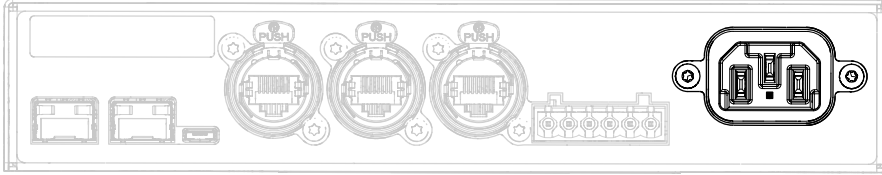

2. Connect the power cord country-specific plug to the mains socket.

Power consumption

LS10 power requirement is 10 W. For an LS10 that powers another LS10 via 24 V DC, it is 20 W.

Powering on/off

LS10 features one power LED indicator. To power LS10 on, connect the IEC cable. LS10 is detected and operational in less than 5 seconds.

To power the switch off, unplug the power cord from the mains socket.

Operation

LS10 LED colors

LS10 is equipped with 12 LED indicators:

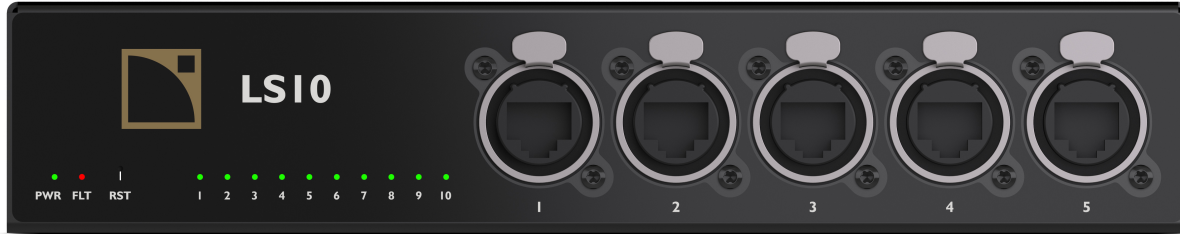

- 10 Link/Act indicators
- 1 Fault indicator
- 1 Power indicator

Colors and meaning

Power	green	powered
	off	not powered
Fault	red	fault detected
	off	nothing to report
Link/act indicators	green	link established
	blink	link active
	off	link not established

! If a Link/act indicator is off even if the network cable is properly connected and not damaged, it may indicate that the corresponding Ethernet port is disabled. Refer to [Ports settings](#) (p.33).

Reset button

It is possible to reset LS10 to factory default settings using the Reset button.

Press the **RST** button and hold it for seven seconds to set back the switch to factory default settings.

It sets back:

- the default IP address to 192.168.1.200
- the default subnet mask to 255.255.255.0
- the default options of the switch

It is also possible to reset LS10 with the LS10 Manager. Refer to [LS10 Manager](#) (p.27).

LS10 Manager

LS10 can be remotely configured using the **LS10 Manager** application. The application is available from the main menu of LA Network Manager, Utilities section, version 3.2.1 minimum.

LS10 Manager allows to configure the connected LS10 with the following parameters:

- display and change the IP address
- update the firmware to the latest version
- check the status of the switch and the ports
- customize the switch options (RSTP, gPTP, Error Auto Recovery)
- define the fault conditions to include in the GPO (General Purpose Output Logic)
- retrieve the embedded log files when required
- reset to factory default settings if necessary

To be detected by **LS10 Manager**, LS10 must be connected to the computer with an Ethernet cable and its IP must be on the same subnet as the computer. If LS10 must be used on a different subnet, connect it with a micro USB cable and use the **USB Terminal** application for basic IP settings.

Refer to the **LA Network Manager Help** for more information on **LS10 Manager** and **USB terminal**.

LS10 embedded Web interface



The embedded Web interface is available from firmware version 2.13.2.

Connect LS10 to the control computer using an Ethernet cable. Open a Web browser and enter the IP address of LS10 to open the LS10 embedded Web interface.



Default IP address is 192.168.1.200.

The LS10 embedded Web interface can also be accessed from the L-Acoustics Device Scanner. Refer to the **L-Acoustics Device Scanner** user guide for more information.

Top bar

The LS10 embedded Web interface displays a top bar with configuration tools and general status.

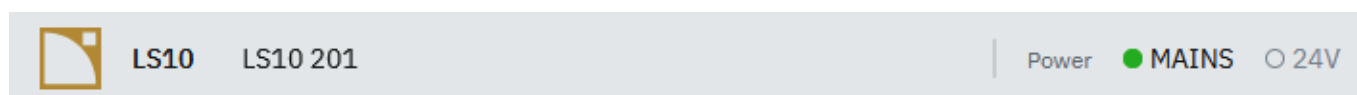

Name

An LS10 can be given a name to identify it. Giving a name can help distinguish different devices in the same system, as the name appears in the tabs of the Web browser used to display the embedded Web interfaces, as well as in L-Acoustics Device Scanner.

To edit, click the field and enter the name.

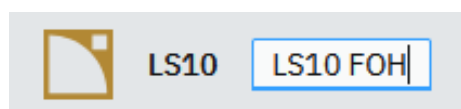

Power status



The power status displays the power presence on mains and 24 V DC input.

Overview

The **Overview** tab displays port status and device information.

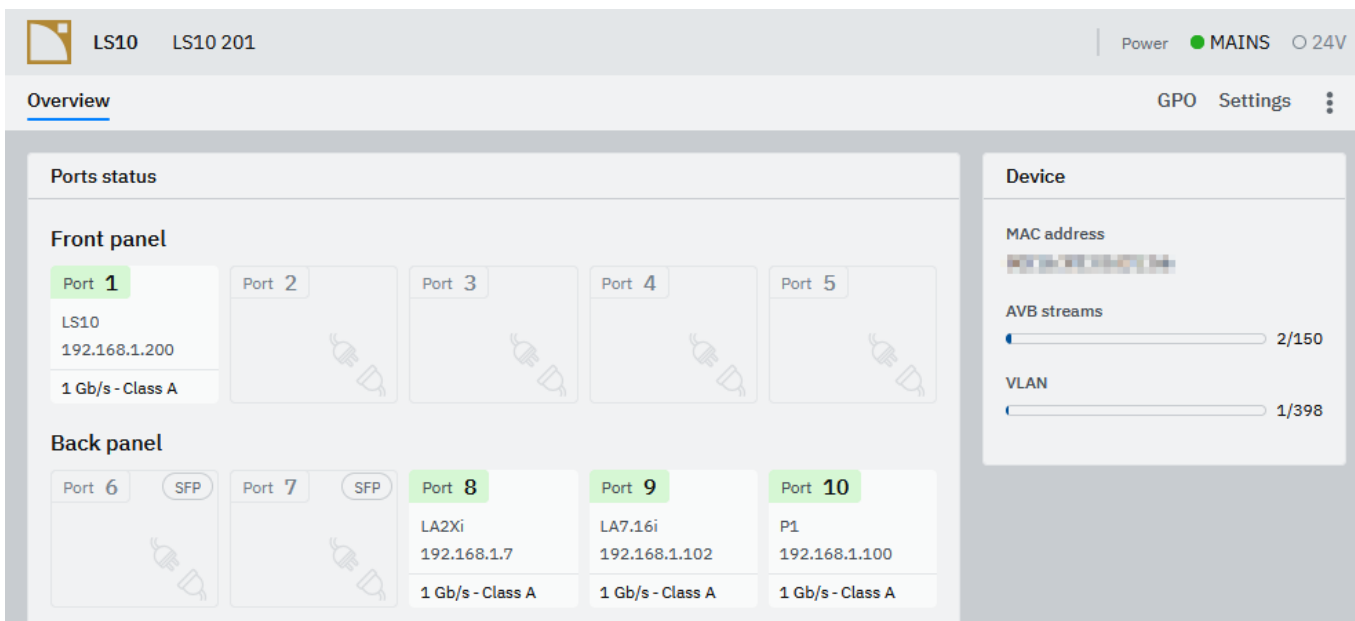

Ports status

The **Ports status** panel displays the status of the ten Ethernet ports.

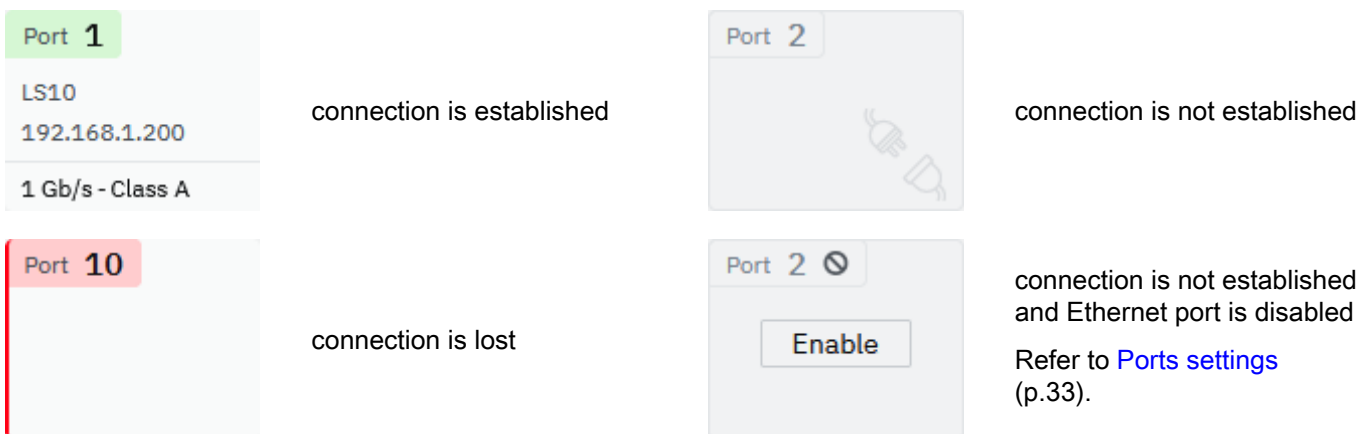

i LLDP (Link Layer Discovery Protocol) is supported on all L-Acoustics devices running firmware version 2.14.0 or more recent.

When connected to a device that supports LLDP, the system description and management address values are displayed in the port tile. When connected to an L-Acoustics device, system description displays the device type and management address displays the IP address.

Selecting a tile opens a side panel with an extended view.

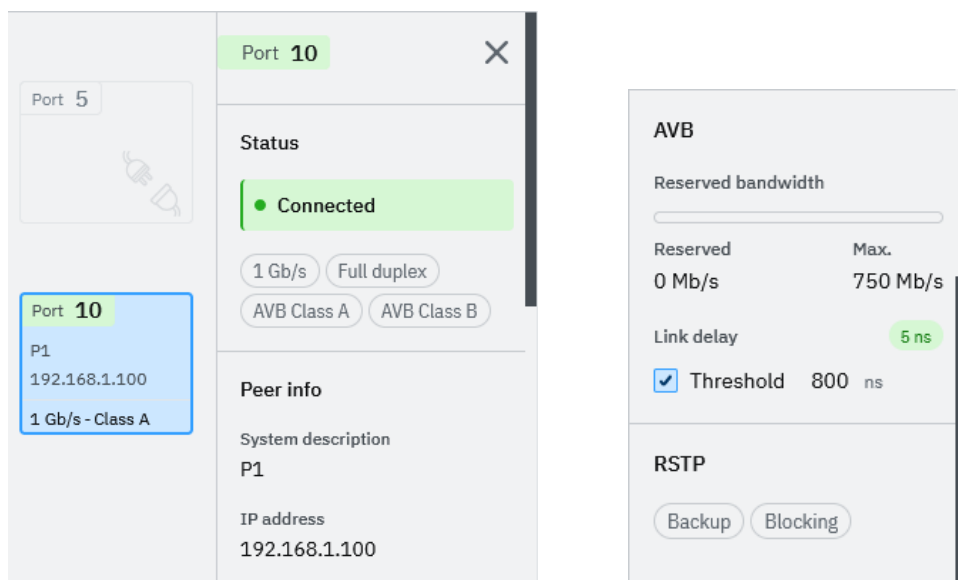

- **Status:** displays the status of the selected port.
- **Peer info:** displays the system description and the management address of the connected device. For an L-Acoustics device running firmware version 2.14.0 or more recent, system description displays the device type and management address displays the IP address. If the value is not defined, or if the connected device does not support LLDP, N/A is displayed.
- **AVB:** displays the reserved bandwidth and the link delay of the selected port. A delay threshold of 800 ns is enabled by default for all ports except SFP ports 6 and 7. For SFP ports, the link delay threshold is disabled by default to allow long fiber links.
- **RSTP:** displays the RSTP roles for the selected port.

If the loss of a connection is expected (for example after disconnecting or turning off a connected device), click **Reset error** to change the status of the Ethernet port to idle.

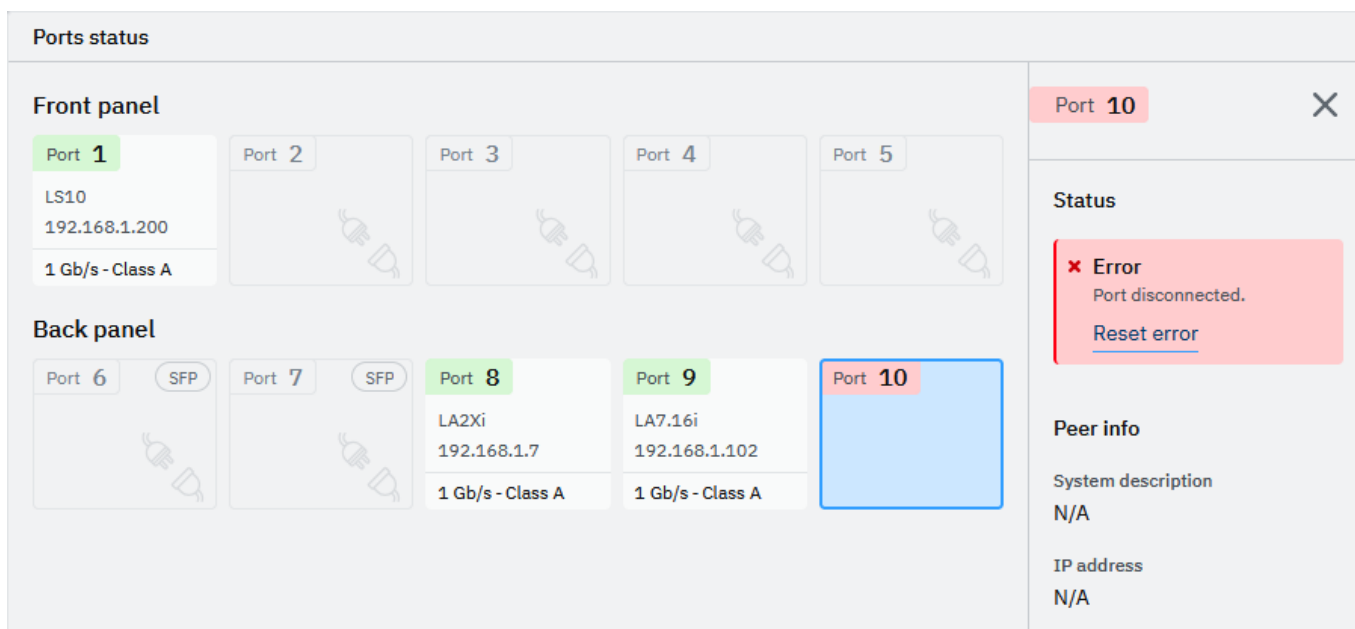

Device

The **Device** panel displays the MAC address of LS10 and the number of AVB streams and VLAN managed by LS10.

GPO

Use the GPO tab to configure the LS10 GPO. Refer to [General Purpose Output \(GPO\)](#) (p.17) for more information on the GPO connector.

List of functions

List of GPO functions available with firmware 2.13.2. This list may evolve in future firmware releases.

Function name	Description	Options
Choose a function	The GPO is not used.	N/A
State	Manually set the GPO state.	Switch state
Alive	Periodically switch between OPEN and CLOSED states.	Choose a time lapse period (1 to 60 seconds)
Fault	Report a selection of possible faults.	<ul style="list-style-type: none"> • Ethernet ports 1 to 10 • Mains • 24 V in • 24 V out

Alive

The GPO state is alternating between OPEN and CLOSED states every time the time lapse period (set from 1 to 60 seconds) is elapsed.

Fault

Multiple selection is possible among the available fault options. If any of the selected options is reporting a fault, then the GPO reports a fault. A fault is reported by the GPO state OPEN. In case of no fault detected, the GPO state is CLOSED.

GPO state	Condition
OPEN	At least one of the selected options is reporting a fault: <ul style="list-style-type: none"> • At least one of the selected Ethernet ports is DOWN, or there are no Ethernet ports selected for this function. • At least one of the selected Power options is DOWN.
CLOSED	All the selected options are not reporting any fault: <ul style="list-style-type: none"> • All selected Ethernet ports are UP. • All selected Power options are UP.

Settings

The **Settings** gives access to panels to configure LS10 network, port settings, and to update LS10 firmware.

Network

Use the **Network** panel to edit the network configuration of LS10.

IP Settings

Click **EDIT** to configure the **IP settings** (IP address, netmask, and gateway).



After applying a change to the IP address, the Web browser is redirected to the new IP address.

An IP address is a unique identifier for a network device on a given IP network. In IPv4 networking, it is made of 4 bytes (32 bits). An IP address is composed of a subnet address and a host address. The host address serves as a unique device identifier on the subnet. The subnet mask determines how many bits define the subnet address, and how many define the host address.

By convention, the first possible number of the host address is reserved to designate the subnet, and the last number is reserved to communicate with all devices of the subnet (IP broadcast address).

The factory default IP settings of all L-Acoustics devices are:

- IP address: 192.168.1.100
- Subnet address: 192.168.1.0/24
- IP broadcast address: 192.168.1.255
- Subnet mask: 255.255.255.0

With these settings, the first three bytes of the IP address (192.168.1) define the subnet address, and the last byte is the host address (100).

In general, it is recommended to:

- Use the default subnet address and subnet mask.
- Edit the device host address to provide a unique identifier to each unit: use consecutive IP addresses starting from 192.168.1.1 up to 192.168.1.253.
- Set the control computer to 192.168.1.254.

However, it is possible to configure other IP settings when required by network administration. Subnet mask may be defined from 255.0.0.0 to 255.255.255.0, and the IP and gateway addresses must both belong to one of the following IP ranges (standards for Private Local Area Networks):

- 10.0.0.1 to 10.255.255.254
- 100.64.0.1 to 100.127.255.254
- 172.16.0.1 to 172.31.255.254
- 169.254.0.1 to 169.254.255.254 (not recommended)
- 192.168.0.1 to 192.168.255.254

! **LS10 must be using the same subnet and subnet mask as the Ethernet card used on the control computer.**

A gateway IP address is an advanced setting reserved for specific applications such as amusement parks, campuses, and multi-room venues with a centralized third-party supervision tool (Crestron, Q-SYS, etc.). In such contexts, the supervision tool is often located in a different subnet that is interconnected with the subnets of the units. Interconnection is achieved using a gateway. The gateway address must be set on the units to enable communication with the supervision tool.

RSTP

Enable/Disable the RSTP (Rapid Spanning Tree Protocol).

When RSTP is enabled, the protocol detects and automatically disables Ethernet ports to cut loops created by redundant links in the network, and avoid damaging broadcast storms. In case of a cable or switch failure in the network, the protocol can re-enable these ports to restore connectivity.

Enable RSTP if the LS10 is part of a network loop. Disable RSTP if there is no risk of LS10 being part of a network loop.

gPTP

Adjust the values of **Priority 1** and **Priority 2** to define the priority ranking of LS10 in the election of the gPTP grandmaster clock. A lower value corresponds to a higher priority.

- !** In most cases, it is recommended to leave the default **Priority 1** and **Priority 2** values and let the BMCA (Best Master Clock Algorithm) elect the AVB grandmaster clock in the network.
- !** The AVB network clock is different from the media clock. The AVB network clock is the reference ToD (Time of Day, also known as wall-clock time) for the AVB domain and is typically provided by a network switch. In AVB networks, the media clock must be selected using AVDECC controllers such as LA Network Manager, Milan Manager, or Hive.

A **Me** label is displayed when the device is elected as grandmaster clock.

gPTP

Priority 1	Priority 2
246	248

Grandmaster
0x001b92ffe050155

Device info

Use the **Device info** panel to check the version number and the date of the firmware currently installed on LS10, update the firmware, and check the MAC address and the serial number of LS10.

Click **Update** to browse to the firmware file location on the control computer. The firmware update process reboots LS10.

! After a firmware update, clear the Web browser cache to make sure the LS10 embedded Web interface is properly refreshed.

Ports settings

i The **Ports settings** panel is available from firmware version 2.13.3.

The **Ports settings** panel displays the unused Ethernet ports of LS10.

To make sure that no device can be connected to the unused Ethernet ports, click **Disable** to disable all unused Ethernet ports. Click **Enable** to enable all unused Ethernet ports.

Disabled ports can also be enabled from the [Overview](#) (p.28) tab.

Ports status

! Unused ports have been disabled Enable all disabled ports

Front panel

<div style="background-color: #e0ffe0; padding: 2px; border: 1px solid #add8e6; margin-bottom: 5px;">Port 1</div> <div style="padding: 5px; border: 1px solid #add8e6;"> LS10 192.168.1.200 1 Gb/s - Class A </div>	<div style="background-color: #e0e0e0; padding: 2px; border: 1px solid #add8e6; margin-bottom: 5px;">Port 2 ⋮</div> <div style="padding: 5px; border: 1px solid #add8e6; text-align: center;">Enable</div>	<div style="background-color: #e0e0e0; padding: 2px; border: 1px solid #add8e6; margin-bottom: 5px;">Port 3 ⋮</div> <div style="padding: 5px; border: 1px solid #add8e6; text-align: center;">Enable</div>	<div style="background-color: #e0e0e0; padding: 2px; border: 1px solid #add8e6; margin-bottom: 5px;">Port 4 ⋮</div> <div style="padding: 5px; border: 1px solid #add8e6; text-align: center;">Enable</div>	<div style="background-color: #e0e0e0; padding: 2px; border: 1px solid #add8e6; margin-bottom: 5px;">Port 5 ⋮</div> <div style="padding: 5px; border: 1px solid #add8e6; text-align: center;">Enable</div>
---	---	---	---	---

Back panel

<div style="background-color: #e0e0e0; padding: 2px; border: 1px solid #add8e6; margin-bottom: 5px;">Port 6 ⋮ SFP</div> <div style="padding: 5px; border: 1px solid #add8e6; text-align: center;">Enable</div>	<div style="background-color: #e0e0e0; padding: 2px; border: 1px solid #add8e6; margin-bottom: 5px;">Port 7 ⋮ SFP</div> <div style="padding: 5px; border: 1px solid #add8e6; text-align: center;">Enable</div>	<div style="background-color: #e0ffe0; padding: 2px; border: 1px solid #add8e6; margin-bottom: 5px;">Port 8</div> <div style="padding: 5px; border: 1px solid #add8e6;"> LA2Xi 192.168.1.7 1 Gb/s - Class A </div>	<div style="background-color: #e0ffe0; padding: 2px; border: 1px solid #add8e6; margin-bottom: 5px;">Port 9</div> <div style="padding: 5px; border: 1px solid #add8e6;"> LA7.16i 192.168.1.102 1 Gb/s - Class A </div>	<div style="background-color: #e0ffe0; padding: 2px; border: 1px solid #add8e6; margin-bottom: 5px;">Port 10</div> <div style="padding: 5px; border: 1px solid #add8e6;"> P1 192.168.1.100 1 Gb/s - Class A </div>
---	---	--	--	--

Error recovery

Enable/Disable the automatic error recovery.

Error recovery

Automatic

The automatic error recovery is generally used in redundant network topologies. In case of optical link disconnection, the FLT (Fault) LED may blink. In this case, it is necessary to reset internal components in order to recover from the optical port incident. The Error Auto Recovery enables the automatic reset of LS10 in case of optical link disconnection. It takes a few milliseconds to apply.



Brief stream interruption

All the ports reset at the same time and this triggers a brief stream interruption even for streams forwarded by copper ports.

Additional actions

Click the three dots on the right to open a menu for additional actions.

Reboot

Reboot LS10.

Reset to factory defaults

Reset LS10 to factory default settings.

Specifications

LS10 specifications

All values given in this section are typical values.

General

Mains rating	100 V AC - 240 V AC ($\pm 10\%$), 50 Hz - 60 Hz
Power consumption	10 W - 20 W max when powering another LS10
Backup power circuit	24 V DC back-up input 24 V DC output for powering another LS10
External backup power supply requirements	24 V DC ($\pm 10\%$) 10 W minimum (over -5 °C / 23 °F to 50 °C / 122 °F ambient)
Startup time	ready to forward AVB streams in 5 seconds
Plug-and-play	open standard (no license required), AVB-enabled without configuration, no manual configuration required

Storage and operating conditions

Storage temperature	-5 °C / 23 °F to 70 °C / 158 °F
Operating temperature	-5 °C / 23 °F to 50 °C / 122 °F
Maximum altitude	2000 m
Climate	moderate, tropical

Interface

Indicators	1 LED for power status, 1 LED for fault status 10 LEDs for link/act status
Button	reset to factory settings

Ethernet port features

Management	gPTP grandmaster capable, priority selection RSTP: enable/disable
Port sensing	auto negotiation
Auto crossover	MDI / MDIX (allows to use straight or cross cables)
Auto sensing	Full or Half Duplex (Gigabit is always Full Duplex Mode)
AVB ports	10 ports at 10/100/1000 Mb/s

Connectors

Network	8 × Ethernet etherCON [®] I/O (5 on front, 3 on rear) 2 × SFP cages
Mains input	IEC C13 V-Lock compatible socket
Terminal block connector	5 mm 6-point terminal block connector for GPO and DC powering with: <ul style="list-style-type: none"> • 1 × 24 V DC power output (maximum 10 W) to power another LS10 • 1 × 24 V DC backup power input (maximum 10 W) • 1 GPO for fault indication (Relay, max 30 V DC / 1 A)

USB female micro USB type

Milan-AVB

Featured AVB entities Avnu™-certified Milan-AVB Bridge
 Standards Ethernet Milan-AVB: IEEE 802.1BA-2011 standard augmented by Avnu ProAV 1.1 requirements
 Supported streams Number: 150
 Class: A and B

Management

IP static
 Firmware update through Ethernet

Physical data

Height × Width 1.7 in × 8.5 in (1U × 1/2U)
 Weight 1 kg / 2.2 lb
 Finish black
 Protection rating IP2x

LS10 dimensions

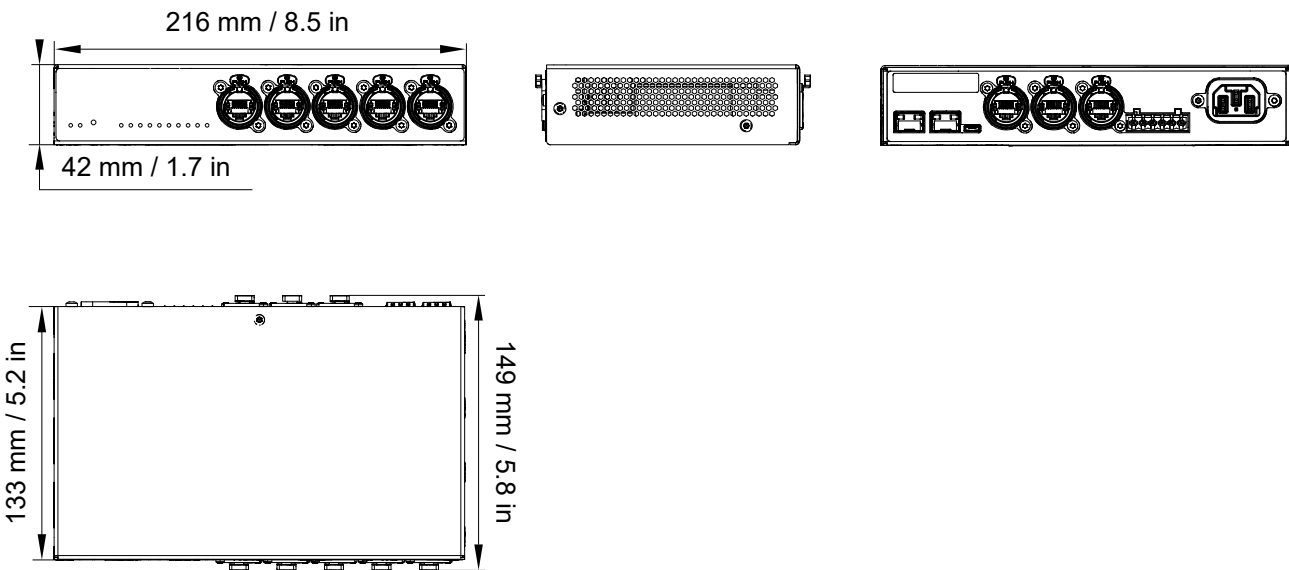

LS10-RAKSHELF specifications

Description	1U Rack shelf for two LS10
Weight (net)	1.1 kg / 2.4 lb
Material	electrogalvanized steel

LS10-RAKSHELF dimensions

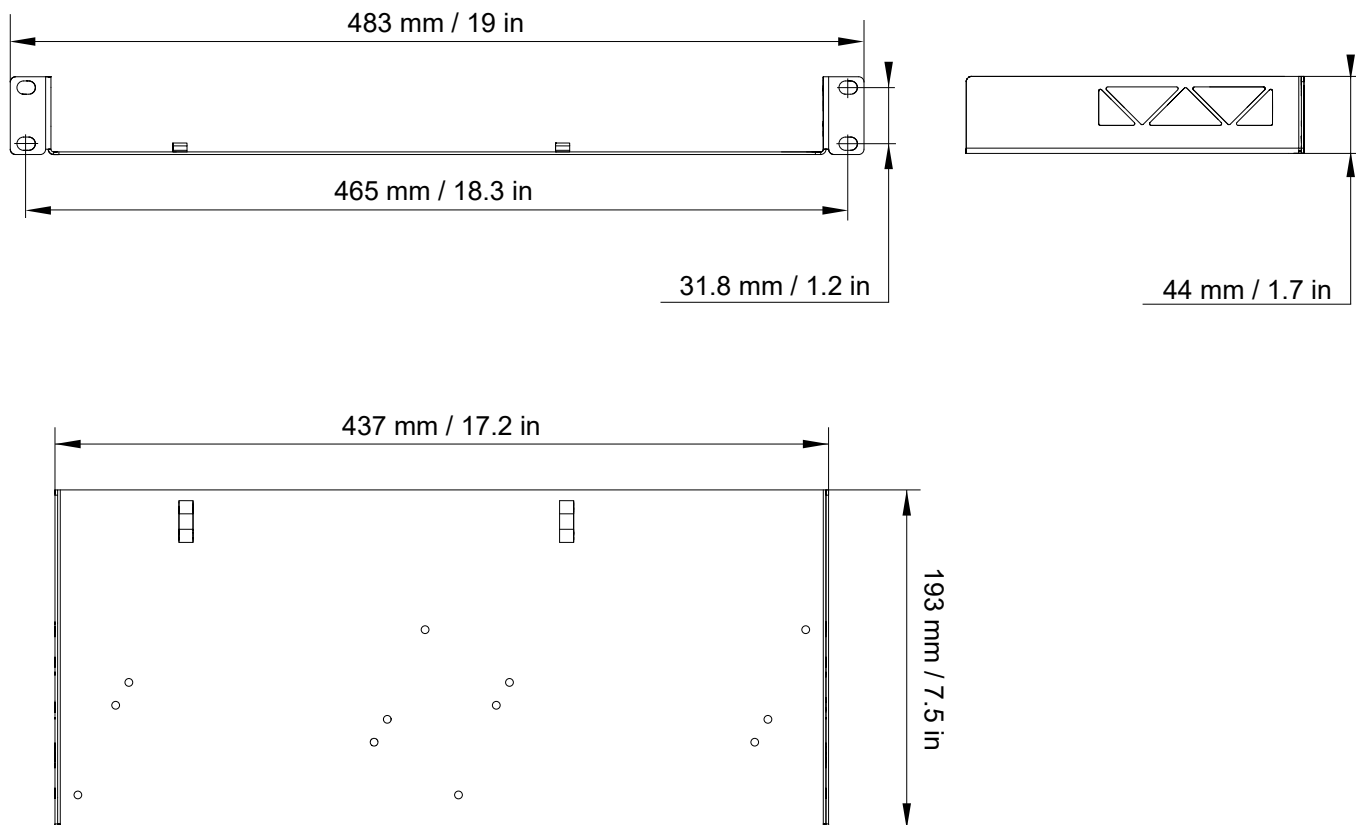

Appendix

Glossary

CE	Europe
CHK	check procedure
CN	China
D/R	disassembly/reassembly procedure
INT	international (bare lead version of the power cable)
JP	Japan
KR	repair kit
SMPS	Switched Mode Power Supply (power supply inside of the amplified controller)
US	United States

Approvals

EU Declaration of Conformity (DoC)

EU Declaration of Conformity (DoC)

We

L-Acoustics
 13 rue Levacher Cintrat
 Parc de la Fontaine de Jouvence
 91460 Marcoussis Cedex
 France
 +33 (0)1 69 63 69 63
 info@l-acoustics.com

declare that the DoC is issued under our sole responsibility and belongs to the following product:

LS10 network switch

The object of the declaration described above is in conformity with the relevant Union harmonization legislation:

2014/35/EU: Low Voltage Directive
2014/30/EU: Electro-Magnetic Compatibility Directive
2011/65/EU: RoHS 2 Directive

The following harmonized standards and technical specifications have been applied:

EN 62368-1: 2014 Audio/video, information and communication technology equipment — Part 1: Safety requirements
EN 55032: 2015 Electromagnetic compatibility of multimedia equipment — Emission Requirements
EN 55035:2017 Electromagnetic compatibility of multimedia equipment — Immunity requirements

Technical file compiled by:

Genio KRONAUER
 13 rue Levacher Cintrat
 Parc de la Fontaine de Jouvence
 91460 Marcoussis Cedex
 France

Year CE marking was first affixed: 2020

Issued in Marcoussis, France 09.07.2020



Genio KRONAUER, Electronics Director

LS10 is compliant with the following:



Avnu Alliance and the Avnu design mark are registered trademarks and/or service marks of Avnu Alliance.

QoS priority queues

DiffServ / Traffic priority queues

LS10 has 8 priority queues on each egress port, with the following predefined QoS (Quality of Service) criteria:

Priority queue	DSCP range	Usage
7 (highest priority)	N/A	AVB Class A
6	N/A	AVB Class B
5	N/A	RSTP, gPTP, MRP
4	52-63	Dante PTP
3	39-51	AES67/Q-LAN PTPv2, Dante audio
2	26-38	AES67/Q-LAN audio
1	8-25	Dante (reserved)
0 (lowest priority)	0-7	Other traffic



L-ACOUSTICS

L-Acoustics

13 rue Levacher Cintrat - 91460 Marcoussis - France

+33 1 69 63 69 63 - info@l-acoustics.com

www.l-acoustics.com

 **L-ACOUSTICS**

GROUP